

**Sec. 36-1. Findings.**

The city council finds it necessary to accomplish the following:

- (1) Protect the residential, business, industrial and public areas of the community and maintain their stability.
- (2) Promote the most appropriate and orderly development of the residential, business, industrial and public areas.
- (3) Provide adequate light, air and convenient access to property.
- (4) Limit congestion in the public rights-of-way.
- (5) Prevent overcrowding of land and undue concentration of structures by regulating the use of land and buildings and the bulk of buildings in relation to the land surrounding them.
- (6) Provide for compatibility of different land uses.
- (7) Require that development proceed according to the principles, goals, objectives, implementation strategies, and land use designations established in the city's comprehensive plan.
- (8) Maintain a tax base necessary to the economic welfare of the city by insuring optimum values for property in the city.
- (9) Enhance the aesthetic character and appearance of the city.
- (10) Conserve natural resources and environmental assets of the community.
- (11) Provide adequate off-street parking and loading facilities.
- (12) Define the powers and duties of the board of zoning appeals and the planning commission.
- (13) Provide effective administration of this chapter and any future amendments to the ordinance from which this chapter is derived and prescribe penalties for the violation of its requirements.
- (14) Establish a continuing system of review of this chapter to ensure it will be amended to meet the changing needs of the community and advances in science and the arts.

(Code 1976, § 14:1-1.2)

**Sec. 36-2. Purpose and intent of chapter.**

To implement these findings, the city council, through this chapter, establishes minimum requirements to protect the public health, safety, morals, comfort, convenience and general welfare of the people. This chapter shall divide the city into use districts and establish regulations which control the location, erection, construction, reconstruction, alteration and use of structures and land.

(Code 1976, § 14:2)

**Sec. 36-3. Rules of construction.**

**(a) Construction.** The following rules of construction govern the interpretation of the language of this chapter:

- (1) The singular number includes the plural and the plural the singular.
- (2) The present tense includes the past and future tenses and the future includes the present.
- (3) The word "shall" is mandatory, and the word "may" is permissive.

Whenever a word or term which is defined in this chapter appears in the text of this chapter, its meaning shall be that stated in the chapter definition. Words or terms which are not defined in this chapter shall have the meaning found in the most recent edition of Webster's Unabridged Dictionary. Words not defined in that dictionary shall have their ordinary, usual meaning at the time the word or term is being applied to a zoning question or situation. General words are construed to be restricted in their meaning by preceding particular words.

**(b) Interpretation.** The following rules apply to determine the boundaries of a zoning district or the status of a land use:

- (1) *Zoning district boundaries.*
  - a. In determining the location of zoning district boundaries, the zoning administrator shall consider the provisions of section 36-114. If these provisions are not applicable and distances and dimensions are not labeled, the zoning administrator shall determine the location of the line by scaling from the official copy of the zoning map.
  - b. If the zoning administrator determines the location of the zoning district boundary along a line which passes through a building or structure, the boundary line shall be adjusted so that the line falls outside of the building or structure at a location most compatible with the purpose and intent of this chapter.
- (2) *Land use.*
  - a. The only uses which can be made are those uses listed in the district and these are permitted only in the manner described by this chapter.
  - b. Any person seeking to establish a use of land or a building which is not specifically listed in any of the use categories in this chapter may ask the zoning administrator which category of use shall be applied. The zoning administrator's decision will establish whether the proposed use is permitted under any of the categories in this chapter. The zoning administrator shall consider functional similarities between uses listed in this chapter and the proposed use including nuisance characteristics, traffic, appearance and mode and hours of operation in making this determination. The determination of the zoning administrator shall be in writing and shall include a statement whether the use is designated as "permitted," "permitted with conditions," "permitted as a conditional use" or "permitted as an accessory use." If the zoning administrator determines that the proposed use is not permitted under any category, that conclusion shall be stated in the written determination.

- (3) *Appeal.* Any decision of the zoning administrator determining zoning district boundaries or permitted land uses may be appealed to the board of zoning appeals under the provisions of subsection 36-31(a).
- (4) *Performance time; delivery and filing time.* Where the performance or doing of any act, duty, matter, payment or thing is ordered or directed and the period of time or duration for the performance or doing thereof is described and fixed by this chapter, the time shall be computed so as to exclude the first and include the last day of the prescribed or fixed period or duration of time. When the last day of the period falls on Saturday, Sunday, or a legal holiday, that day shall be omitted from the computation. When an application, payment, drawing, contract or other document is to be delivered to or filed with any department of the city or other unit of government on or before a prescribed date and the prescribed date falls on a Saturday, Sunday, or legal holiday, it is timely delivered or filed if it is delivered or filed on the next succeeding day which is not a Saturday, Sunday, or legal holiday.
- (5) *Purpose of interpretation and construction of chapter.* The object of all interpretation and construction of this chapter is to ascertain and effectuate the intention of the city council. This chapter shall be construed, if possible, to give effect to all the chapter provisions. When the words of this chapter in their application to an existing situation are clear and free from all ambiguity, the letter of this chapter shall not be disregarded under the pretext of pursuing the spirit.
  - a. When the words of this chapter are not explicit, the intention of the city council may be ascertained by considering, among other matters:
    1. The occasion and necessity for this chapter or specific provision.
    2. The circumstance under which it was enacted.
    3. The mischief to be remedied.
    4. The object to be attained.
    5. The former zoning ordinance.
    6. The consequences of a particular interpretation.
    7. Administrative interpretations of this chapter and interpretations by the board of zoning appeals and the city council.

- b. In ascertaining the intention of the city council, the following presumptions apply:
1. The city council does not intend a result that is absurd, impossible of execution, or unreasonable.
  2. The city council intends the entire chapter to be effective and certain.
  3. The city council does not intend to violate the Constitution of the United States or the state constitution.
  4. The city council intends to favor the public interest as against any private interest.
- (6) *Grammatical errors.* Grammatical errors shall not destroy the application of this chapter. A transposition of words and clauses may be resorted to when a sentence is without meaning as it stands. Words and phrases which may be necessary to the proper interpretation of this chapter and which do not conflict with its obvious purpose and intent, nor in any way affect its scope in operation, may be added in the construction thereof.
- (7) *Provisos.* Provisos shall be construed to limit rather than to extend the operation of the clauses to which they refer. Exceptions expressed in this chapter shall be construed to exclude all others.
- (8) *Penalty; forfeiture.* When a penalty or forfeiture is provided for the violation of this chapter, such penalty or forfeiture shall be construed to be for each such violation. Each day that a violation exists shall constitute a separate violation.
- (9) *Provision conflicts.* When a general provision of this chapter conflicts with a special provision in this chapter, the two shall be construed if possible so that effect shall be given to both. If the conflict between the two provisions is irreconcilable, the special provisions shall prevail and shall be construed as an exception to the general provision unless the general provision was enacted subsequent to the special provision and it shall be the manifest intention of the city council that such general provisions shall prevail. When several clauses are irreconcilable, the chapter clause last in order of date or position shall prevail. When the provisions of two or more amendments to this chapter passed at different dates are irreconcilable, the amendment latest in date of final enactment shall prevail.

- (10) *Amendment.* When a section or part of the ordinance from which this chapter is derived is amended, the amendment shall be construed as merging into the original ordinance, becoming a part thereof, and replacing the part amended, and the remainder of the original ordinance and the amendment shall be read together and viewed as one ordinance passed at one time. The portions of this chapter which were not altered by the amendment shall be construed as effective from the date of the first enactment, and the new provision shall be construed as effective only from the date when the amendment became effective. When this chapter adopts the provisions of state statute by reference, it also adopts by reference any subsequent amendments of that statute except when the intent of the city council is clearly to the contrary. If two or more amendments to the same provision or this chapter are enacted at the same or at different times, one amendment overlooking and making no reference to the other, the amendments shall be construed together if possible and effect be given to each. If the amendments are irreconcilable, the amendment latest in date of final enactment shall prevail.
- (11) *Appendix.* The appendix is for information purposes only and is not intended to govern.
- (12) *Diagrams.* Diagrams, where provided, are intended to be illustrative only and may not be drawn to scale. Where a conflict exists between a diagram and text, the text shall prevail.

**(c) Separability.** Provisions in this chapter are separable if the following events occur:

- (1) If a court of competent jurisdiction finds any provision of this chapter to be invalid, that judgment shall not affect any other provision of this chapter not specifically included in the judgment.
- (2) If a court of competent jurisdiction finds the application of any portion of this chapter to a particular property, building, or other structure invalid, that judgment shall not affect the application of the provision to any other property, building or structure not specifically included in the judgment.
- (3) If a court of competent jurisdiction finds any individual condition of a conditional use permit invalid, that judgment shall not invalidate any other condition of the same conditional use permit not specifically included in such judgment nor shall it invalidate the application of the same condition in any other conditional use permit.

**(d) Jurisdiction and authority.**

- (1) This chapter is enacted under the authority granted to the city in state statutes. If those statutes are amended to restrict or enlarge the authority delegated to the city, those amendments shall be incorporated into this chapter.
- (2) Any action by the city to extend the time limit to process a zoning application in accordance with Minn. Stat 15.99, as amended, may be taken administratively without city council approval.
- (3) This chapter governs the use of all land and structures in the city unless such regulation is specifically preempted by state or federal statutes or regulations.  
(Ord. No. 2419-12, 9-14-12)

**(e) Application.**

- (1) *Minimum requirements.* The provisions of this chapter are the minimum requirements for the promotion of the public health, safety, morals and general welfare.
- (2) *More restrictive applications.* Where the conditions imposed by any provision of this chapter are either more or less restrictive than comparable conditions imposed by any other applicable law, ordinance, statute, resolution or regulation of any kind, the regulations which are more restrictive or which impose higher standards or requirements shall control.
- (3) *Mixed use.* All regulations applicable to each use in a mixed use development shall be applicable, except where the mixed use is approved under section 36-367 or where parking is approved under subsection (b)(2)l. of section 36-361.
- (4) *Essential services.* Essential services shall be permitted as authorized and regulated by state law and ordinances of the city. Such essential services are exempt from the application of this chapter, except when they are conducted in the FW, FF and FP overlay districts.
- (5) *Measurement.* All measured distance expressed in feet shall be to the nearest tenth of a foot. The measurement of distances when required by this chapter shall be done in a straight line in the plane located at a point one foot above the highest point in the surface of the ground along the path of measurement, from the closest exterior wall (extended vertically if a cantilever) of a building containing the use to the property line of the adjacent street, district, or lot or other boundary line. If the use is not within a building, the measurement shall be the shortest distance from the location of the use to the property line of the adjacent street, district, or lot or other boundary line.

(Code 1976, § 14:2-0; Ord. No. 2419-12, 9-14-2012)

**Sec. 36-4. Definitions.**

The following words, terms, and phrases, when used in this chapter, shall have the meanings ascribed to them in this section, except where the context clearly indicates a different meaning:

*Abandonment* means to cease or discontinue a use or activity for any reason but excluding temporary interruptions to the use during periods of building or remodeling where a valid building permit has been issued or during periods of routine seasonal closure.

*Abutting* means having a common border or boundary with or being separated from such a common border by an alley. This term is used interchangeably with adjacent and adjoining.

*Access aisle* and *aisle* mean the traveled way by which vehicles enter and depart parking spaces.

*Accessory use or structure* means a use or a structure subordinate to the principal use or structure on the same land and customarily incidental thereto. In the case of an accessory structure, both the building footprint and building height of an accessory building are smaller than the principal building.

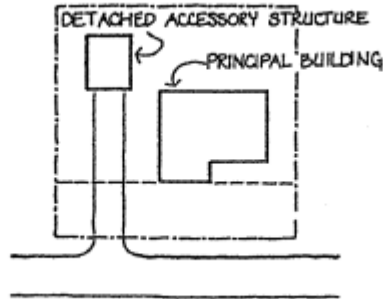

*Adjacent* means having a common border or boundary with or being separated from such a common border by an alley. This term is used interchangeably with abutting and adjoining.

*Adjoining* means having a common border or boundary with or being separated from such a common border by an alley. This term is used interchangeably with abutting and adjacent.

*Alley* means a public right-of-way, with a width not exceeding 24 feet nor less than 12 feet which affords a secondary means of access to property abutting the alley.

*Alteration* means any change, addition, or modification in construction or occupancy of an existing structure or modification to the surface of the ground.

*Basement* means that portion of the building having more than half the ground floor-to-ceiling height below the average grade of the adjoining ground.

*Berm* means a land alteration where fill is added to the surface of the ground in order to create an earthen mound or hill generally used in conjunction with walls, fences, or plant materials to screen one parcel of land from another or from a street.

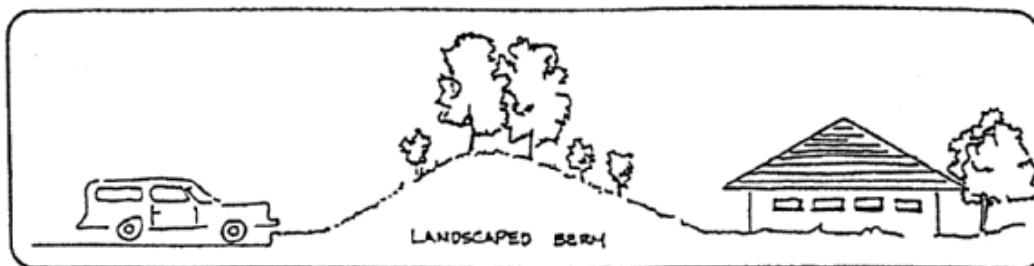

Landscaped Berm

*Block front* means the distance between intersections along one side of a street.

*Boardinghouse* means a building other than a motel or hotel where for compensation or by prearrangement for definite periods, meals or lodging are provided for three or more persons, but not to exceed eight persons.

*Boulevard* means that portion of a street right-of-way between the curblines and property line.

*Building* means any structure having a roof which may provide shelter or enclosure of persons, animals, or personal property.

*Building face* means that portion of the exterior wall of a structure which shall lie in a vertical plane. One face shall be terminated by an exterior angle of at least 210 degrees formed by two exterior walls each being at least 18 feet in length or a curved portion of such exterior wall which shall have a central angle of 30 degrees or more.

*Caliper inch* means a unit of measurement describing the diameter of a tree measured one foot above the finished grade level.

*Canopy tree* means a deciduous tree planted primarily for its high crown of foliage or overhead canopy.

*Carport* means a space for the housing or storage of motor vehicles and enclosed on not more than two sides.

*Channel* means the natural or artificial depression of perceptible extent along Minnehaha Creek with a definite bed and bank to confine and conduct flowing water, either continuously or periodically.

*City* means the City of St. Louis Park, a municipal corporation, along with its duly authorized boards, commissions, and representatives.

*Commercial vehicle.* A motor vehicle is a commercial vehicle if:

- (1) The vehicle is a dump truck, a step van, a tow truck, a semi-tractor or trailer, a tank truck, a tractor, a bus, a cargo truck, a construction vehicle or equipment, an earth-moving vehicle or equipment, a van or pickup with a manufacturer's nominal rated carrying capacity of more than one ton, or any other vehicle which is used in connection with commercial activities.



- (2) Commercial equipment has been added to the vehicle such as winches or snowplows.
- (3) Commercial racks have been added to the vehicle for the purpose of holding equipment or materials.
- (4) The vehicle is a pickup with a nonstandard pickup box; or
- (5) The vehicle is a trailer loaded with another commercial vehicle or commercial equipment.

*Conditional use* means a specific type of structure or land use which is permitted by this chapter only after an in-depth review procedure set forth in section 36-33 and with appropriate conditions or restrictions as provided in this chapter and upon finding that:

- (1) Certain conditions as detailed in this chapter exist; and
- (2) The structure and land use conform to the comprehensive plan and are compatible with the existing neighborhood.

*Condominium* means an estate of real property consisting of an undivided interest in common with other purchasers in a portion of a parcel of real property, together with a separate interest in space in a building. A condominium may include, in addition, a separate interest in other portions of such real property, such as garage space or in the case of cluster development, a townhouse or cluster development lot.

*Curb level* means the grade elevation, as established by the city, at the curb in front of the center of the building. Where no curb level has been established, the director of public works shall determine a curb level or its equivalent for the purpose of this chapter.

*Customer floor area* means that part of the gross floor area of a commercial establishment used by and accessible to the public, except public restrooms.

*Deciduous* means a plant with foliage that is shed annually.

*Density* means the number of dwelling units permitted per net acre of land.

*Designed Outdoor Recreational Area* means designed outdoor space intended for passive or active recreation accessible and suited to the needs of residents and/or employees. The area shall be functional and aesthetic, designed with clear edges, relate to the principal building or buildings, include sidewalk connections, seating, landscaping, and other amenities. The area should be compatible with or enlarge upon existing pedestrian links and public parks or open space and may include swimming pools, tot lots, courtyards, plazas, picnic areas, and trails within natural areas. Outdoor recreational areas shall not include driveways, parking areas, steep slopes, or ponds designed solely for stormwater retention. (Ord. No. 2267-04, 4-12-04)

*Development* means all structures, land uses, and other modifications of the existing landscape above and below ground or water, on a single parcel, or on more than one parcel if covered by a single planned unit development or conditional use permit.

*Diameter at breast height (DBH)* means the diameter of a tree measured at a height of 4 1/2 feet from the ground level.

*District.* See the definition, "Use district."

*Driveway* means an improved access which connects an off-street parking space to the public right-of-way.

*Dog kennel* means any premises where four or more dogs, over four months of age, are owned, boarded, bred, or offered for sale.

*Drip line* means a vertical line extending from the outermost branches of a tree to the ground.

*Dwelling* means a building, or one or more parts of a building occupied or intended to be occupied exclusively for residence purposes, but not including rooms in motels, hotels, nursing homes, boardinghouses, trailers, tents, cabins or trailer coaches.

*Dwelling unit* means one or more rooms physically arranged to create an independent housekeeping establishment for occupancy by one family with separate toilets and facilities for cooking and sleeping.

*Easement* means the grant of one or more of the property rights by the owner to, or for the use by, the public, public utility, corporation, or another person or entity.

*Effective date of the ordinance from which this chapter is derived* means December 31, 1992, the effective date of Ordinance No. 92-1902.

*Enclosed pedestrian walkway* means an enclosed link at or above grade between two buildings on the same or separate lots designed solely for the purpose of transporting pedestrians.

*Equal degree of encroachment* means a method of determining the location of encroachment lines so that the hydraulic capacity of floodplain lands on each side of a stream are reduced by an equal amount when calculating the increases in flood stages due to floodplain encroachments.

*Essential services* include, but are not limited to, underground or overhead gas, electrical, steam or water transmission or distribution systems; collection, communication, supply, or disposal systems including poles, wires, mains, drains, sewers, pipes, conduits, fire alarm boxes, police call boxes, traffic signals, hydrants, or other equipment and accessories in conjunction therewith, bridges, roads, and railroads.

*Evergreen* means a plant with foliage that persists and remains green year-round.

*Excavation* means the removal of soil, rock, minerals, debris, or organic substances other than vegetation from a parcel of land.

*Expansion* means an increase in the floor area or volume of an existing building.

*Facade* means the exterior wall of a building exposed to public view.

*Family* means one of the following:

- (1) Any group of people living together as a single housekeeping unit, all of whom are related by blood, marriage, or adoption plus children who are under foster care.
- (2) Up to four people not so related, living together as a single housekeeping unit.
- (3) Any group of people living together as a single housekeeping unit, if no more than two adult members function as the heads of the household group and the remaining members are dependent upon them for care and direction due to age, physical disability, a mental incompetency or for other reasons.
- (4) Any individual, who is the owner, living and maintaining a common household and using a common cooking and kitchen facility.

*Fence* means any artificially constructed barrier of any material or combination of materials erected to enclose, divide, or screen areas of land.

*Filling* means the placement of sand, gravel, earth, or other materials of any composition on a parcel of land. Also see the definition, "Land reclamation."

*Floor area* means the sum of the gross horizontal areas of the several floors of a building including interior balconies, mezzanines, basements, attics, penthouses, and attached accessory buildings. Measurements shall be made from the inside of exterior walls and to the center of interior walls. For the purposes of determining off-street parking requirements, inside off-street parking or loading space is excluded from floor area.

*Floor area ratio (FAR)* means the numerical value obtained by dividing the total floor area of buildings excluding the basement by the lot area on which such buildings are located.

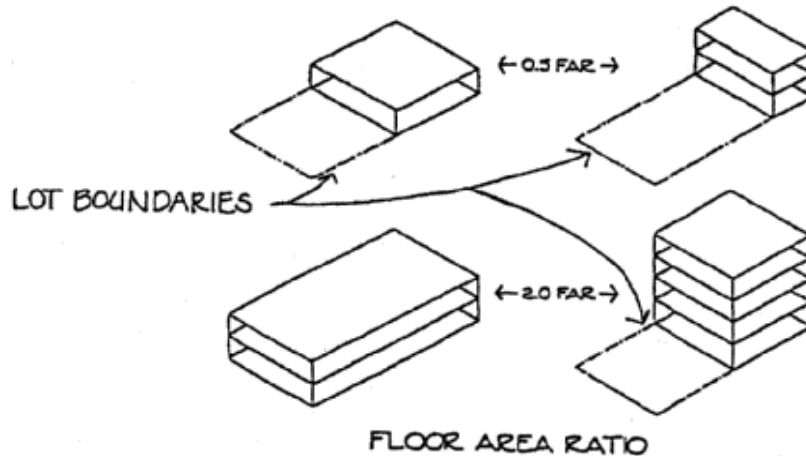

*Food waste* means all food, including meat, poultry, seafood, dairy, bread, fruits and vegetables, cheese, eggshells, rice, beans, pasta, coffee grounds and filters, tea bags, bones and other plate scrapings, and garden food waste (e.g., tomatoes, pumpkins).  
(Ord. No. 2452-14, 5-2-2014)

*Foster family home* means a family home where children out of their own homes are cared for 24 hours a day for a period of 30 days or more.

*Garage, private*, means a detached accessory building or portion of the principal building, including a carport, which is situated on the same lot as the principal building used primarily for storing motor vehicles with no facilities for mechanical service or repair of a commercial nature.

*Grade* means the average elevation of the finished ground level at the midpoint of all walls of a building, or in the case of signs, the average elevation of the finished ground level at the base of a sign. This definition includes the terms finished grade and mean ground level.

*Grading* means excavating, filling or other changes in the earth's natural topography, including stockpiling of earth or land.

*Ground cover* means plants, other than turf grass, normally reaching an average maximum height of not more than 18 inches at maturity.

*Ground floor area* means the lot area covered by a building measured from the exterior faces of exterior walls but excluding decks and terraces and detached garages which do not exceed 15 feet in height.

*Ground Floor Transparency* means the measurement of the percentage of a facade that has highly transparent, low reflectance windows at the pedestrian level, measured between 2' and 8' above grade. (Ord. No. 2575-19, 11-18-19)

*Hedge* means a landscape barrier consisting of a continuous, dense planting of shrubs.

*Height--Accessory building*. A distance to be measured from the first story elevation, as defined by building code, to the highest point of the structure.

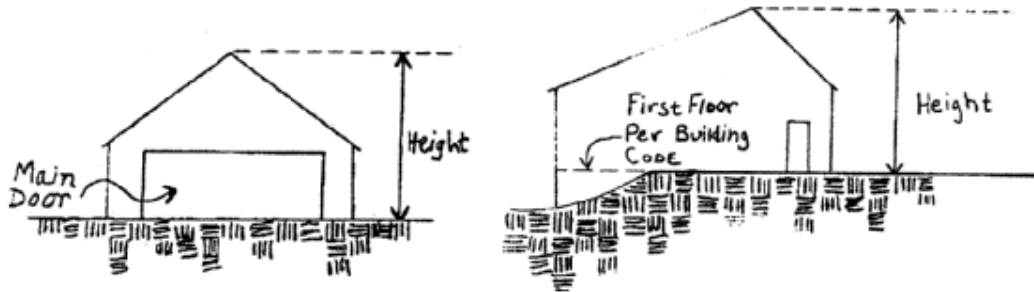

#### Height—Accessory Building

*Height--Accessory structure.* A distance to be measured from the lowest exterior grade at the base of the structure to the highest point of the structure.

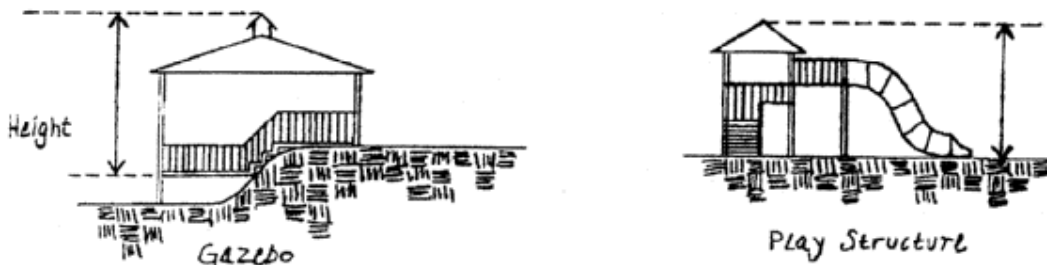

#### Height—Accessory Structure

*Height-Communication Towers and Antennas.* The height of a communication tower or antenna which is not attached to a building shall be determined by measuring the vertical distance from the point of contact with the ground of the communication tower or antenna to the highest point of the communication tower, or antenna, including, in the case of a communication tower, all antennas and other attachments.

(Ord. No. 2367-09, 1-23-09)

*Height--Principal building.* A distance to be measured from the mean curb level along the front lot line or from the finished grade level for all that portion of the structure having frontage on a public right-of-way whichever is higher to the top of the parapet of a flat roof; to the deck line of a mansard roof; to a point on the roof directly above the highest wall of a shed roof; to the upper most point on a round or other arch type roof; or to the mean distance of the highest gable on a pitched or hip roof.

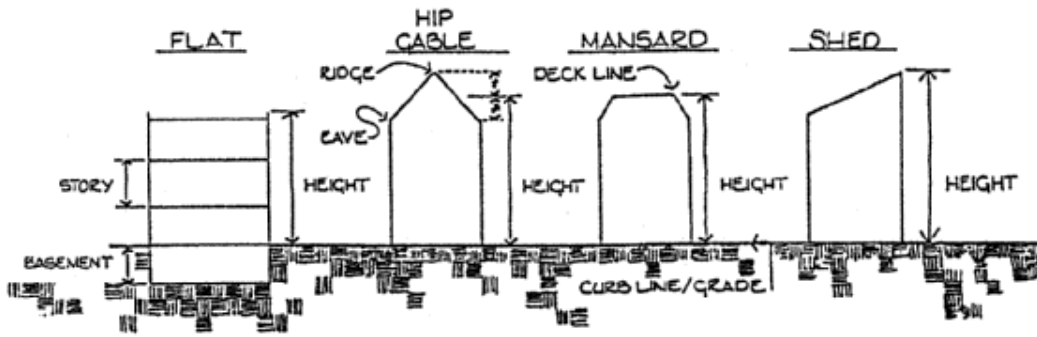

Height—Principal Building

*Impervious surface* means a surface that has been compacted or covered with a layer of material so that it is highly resistant to infiltration by water. It includes surfaces such as compacted sand, lime rock, or clay, as well as most conventionally surfaced streets, roofs, sidewalks, parking lots, and other similar structures.

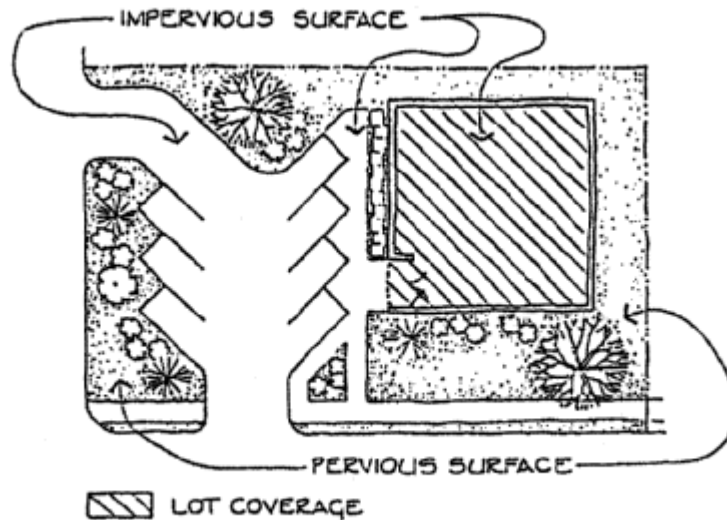

Impervious Surface

*Intensity classification* means a measure of the magnitude and impact of a land use on the environment and neighboring land uses. Variables include, but are not limited to, the levels of traffic that are generated, degree of lot coverage, building height, impervious surface, and density of development.

*Intoxicating liquor license (on-sale)* means an on-sale liquor license issued by the city council which permits the sale and consumption on the licensed premises of all types of legal liquor including spirits, wine, and malt liquor.

*Irrigation system* means a permanent, artificial watering system designed to transport and distribute water to plants.

*Land reclamation* means the reclaiming of land by depositing fill material to elevate the grade. See the definition, "Filling."

*Level of service* means the traffic capacity of an intersection or roadway based upon criteria established by the Institute of Traffic Engineers, as amended periodically.

*Lot* means a parcel of land created by an existing subdivision or described on a deed which has been recorded in the office of the register of deeds or registrar of titles of the county and which is occupied or used or intended for occupancy or use and has common ownership in its entirety.

*Lot area* means the area of a lot in a horizontal plane bounded by the lot lines.

*Lot, buildable*, means a lot which meets the minimum lot width and area requirements of the use district in which it is located and which has frontage on a right-of-way for street or alley purposes. If the lot was subdivided as part of a cluster housing development, access to a public street may be by private street.

*Lot area per family* means the number of square feet of lot area required per dwelling unit.

*Lot, corner*, means a lot situated at the junction of, and abutting on two or more intersecting streets, or a lot at a point of deflection in alignment of a continuous street, the interior angle of which does not exceed 135 degrees.

*Lot depth* means the mean horizontal distance between the front lot line and the rear lot line of a lot.

*Lot, interior*, means a lot other than a corner lot.

*Lot line* means the property line bounding a lot except that where any portion of a lot extends into the public right-of-way, street easement, or a proposed public right-of-way, the line of such public right-of-way or street easement shall be the lot line for applying this chapter.

*Lot line, front*, means that boundary of a lot which abuts a street. In the case of a corner lot, it shall be the shortest dimension on a public street. If the dimensions of a corner lot are equal, the front lot line shall be designated by the owner and filed in the office of the division of inspections. If a parcel has multiple sides on more than two street frontages, the front lot line shall be determined by the zoning administrator.

*Lot line, rear*, means a lot line not intersecting a front lot line that is most distant from and most closely parallel to the front lot line. For a lot bounded by only three lot lines, the rear lot line shall be a line ten feet in length within the lot, parallel to and at the maximum distance from the front lot line.

*Lot line, side*, means a lot line which intersects with a front lot line.

*Lot of record* means any lot which is one parcel of a plat heretofore or hereafter duly approved and filed, or one unit of an auditor's subdivision or a registered land survey or a parcel of land not so platted, subdivided or registered, for which a deed, auditor's subdivision or registered land survey has been recorded in the office of the register of deeds or registrar of titles for the county prior to the effective date of the ordinance from which this chapter is derived.

*Lot, substandard*, means a lot or parcel of land that does not meet the definition of a buildable lot or does not meet the provisions of section 36-71.

*Lot, through*, means a lot which has a pair of opposite lot lines abutting two substantially parallel streets, and which is not a corner lot.

*Lot width* means the horizontal distance between the side lot lines measured at the required front yard line.

*Manufactured home* means a structure, transportable in one or more sections, which, in the traveling mode, is eight body feet or more in width or 40 body feet or more in length, or, when erected on site, is 320 square feet or more, and which is built on a permanent chassis and designed to be used as a dwelling with or without a permanent foundation when connected to the required utilities, and includes the plumbing, heating, air conditioning, and electrical systems contained therein; except that the term includes any structure which meets all the requirements and with respect to which the manufacturer voluntarily files a certification required by the secretary and complies with the standards established under state law.

*Mining* means the extraction and removal of sand, gravel, or other earthen material from a parcel of land.

*Mobile Food Vehicle* means a vehicle or cart used to prepare and serve food and/or beverages.

*Motor vehicle* means every vehicle which is self-propelled. This does not include lawn mowers or snow blowers.

*Mulch* means nonliving organic, synthetic, and rock materials customarily used in landscape design to retard erosion and retain moisture.

*Nonconforming* means a situation where any development, structure, sign, site lighting, off-street parking lot, landscaping, land use or parcel was legally constructed or established prior to the effective date of the ordinance from which this chapter is derived, or subsequent amendment to it, which is not in full compliance with the regulations of this chapter. (Ord. No. 2325-07, 5-7-07)

*Nonconforming parking* means parking which legally existed upon the effective date of the ordinance from which this chapter is derived, and which did not comply with the numerical requirements of section 36-361 or with the design requirements found in the landscaping section of this chapter. (Ord. No. 2325-07, 5-7-07)

*Non-passenger vehicle* means a commercial or recreational vehicle or trailer.

*Open Lot Area* means an area of a lot, not located within a front yard or side yard abutting a street that has a minimum dimension of 20 feet in all directions and does not include a building, driveway, outdoor storage, or parking space. Open covered porches, gazebos, decks, and patios are permitted encroachments into the open lot area. Swimming pools are permitted encroachments provided they do not occupy more than 50% of the open lot area. (Ord. No. 2267-04, 4-12-04)

*Ordinance from which this chapter is derived* means Ordinance No. 92-1902 adopted December 7, 1992, and effective December 31, 1992.



*Organic material* means *Food waste, Yard waste* and items such as, but not limited to non-recyclable paper products, and other compostable items such as full vacuum cleaner bags, dryer lint, tissues and cotton balls, floral trimmings and house plants, and compostable plastics (certified compostable plastic utensils, cups and containers). (Ord. No. 2452-14, 5-2-2014)

*Ornamental tree* means any tree planted primarily for its ornamental value or for screening purposes and tends to be smaller at maturity than canopy trees.

*Parcel.* See the definition, "Lot."

*Parking space* means an improved paved or gravel area on a lot or area within a building intended for parking of a motor vehicle and which has a means of access to a public street. This term is used interchangeably with parking stall and parking facility.

*Passenger vehicle* means an automobile, station wagon, van, sports utility vehicle, minivan, pickup truck, or motorcycle designed and primarily intended for on-street operation. Passenger vehicles do not include commercial vehicles, recreational vehicles, racing cars or stock cars.

*Performance standards* means specified criteria and limitations which are placed on development which are intended to protect the public health, safety, or welfare.

*Person* means an individual, firm, partnership, corporation, company, association, society, joint stock association, or political subdivision of the state including any trustee, receiver, assignee or other representative thereof.

*Pickup truck* means any truck with a manufacturer's nominal rated carrying capacity of one ton or less and commonly known as a pickup or pickup truck and which has a standard manufactured pickup box. A pickup whose standard box is covered with a topper if the topper does not exceed 1 1/2 times the wall height of the standard box is a pickup truck.

*Playfield* means an outdoor facility developed as a baseball diamond, softball diamond, soccer field, football field, or other surface for conducting outdoor recreational activities.

*Previous zoning ordinance* means Ordinance No. 730 adopted December 28, 1959, and all subsequent amendments thereto which were in effect on December 30, 1992.

*Principal building* means a building or group of buildings in which the primary use of a lot is located.

*Principal use* means the main use and chief purpose of land or structures, as distinguished from a secondary or accessory use.

*Proof of parking* means a method by which an area of a lot other than that area required for yards, landscaping, or any other area required for other purposes by this chapter, which is allocated for parking, but is not paved or striped.

*Racing car* means a motor vehicle designed or intended for operation on a speedway, racetrack, or other facility used or designed for high-speed contests between two or more vehicles or for timing of speed.

*Recreational vehicle.*

- (1) Travel trailers include those that telescope or fold down, chassis-mounted campers, house cars, motor homes, tent trailers, slip in campers and converted vans that are motor homes as defined in this definition.
- (2) Motor home is a vehicle that provides temporary living quarters. A vehicle provides temporary living quarters if it is:
  - a. Not used as the residence of the owner or occupant.
  - b. Used for temporary living quarters by the owner or occupant while engaged in recreational or vacation activities; and
  - c. Self-propelled or capable of being towed on public roads.
- (3) A nonmotorized trailer intended and generally used for transporting boats.
- (4) Snowmobiles, all-terrain vehicles, boats, and any type of watercraft. Such vehicles which are placed on a utility trailer shall, together with the trailer, be considered a single recreational vehicle.

*Right-of-way* means an area or strip of land, either public or private, on which a right-of-passage has been recorded for the use of vehicles, including trains, or pedestrians or both.

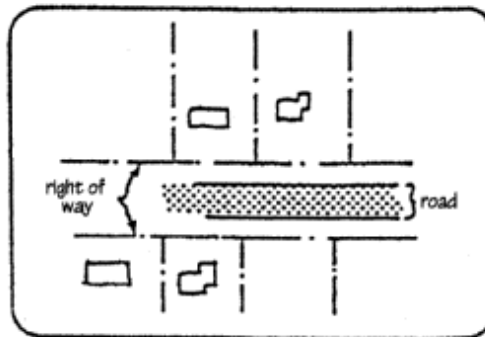

*Root zone* means the part of the soil that is invaded by a plant's roots.

*Screen* means a method of reducing the impact of noise and unsightly visual intrusions by placing vertical elements, such as plants, berms, fences, walls, or any appropriate combination thereof between the incompatible land uses. (Ord. No. 2325-07, 05-07-07)

*Self-Storage Facility* means any real property designed and used for the purpose of renting or leasing individual storage space to individuals, organizations, or businesses who are to have access to such facility for the purpose of storing and removing personal property; a self-storage facility is not a warehouse/storage facility. (Ord. No. 2570-19, 9-16-19)

*Service stall* means the area within a motor fuel station or auto repair facility of adequate size to service one motor vehicle. A service stall shall have a maximum floor area of 400 square feet. This term is synonymous with service bay.

*Shopping Center* means a group of commercial uses planned, owned, and managed as a unit that has common parking facilities. Shopping centers may include more than one building and more than one contiguous property and owner if approved under a single conditional use permit or planned unit development. This use includes vendor markets. (Ord. No. 2598-20, 11-16-20)

*Short-term rental* means leasing a residential dwelling unit or accessory dwelling unit for a term of less than one month. (Ord. 2596-20, 10-19-20)

*Shrub* means a self-supporting woody perennial plant, smaller than a tree, consisting of several small stems from the ground or small branches near the ground; may be deciduous or evergreen, and usually not more than ten feet in height at its maturity.

*Significant tree* means any tree, with the exception of Salix (Willow), Boxelder, Siberian Elm and Black Locust, is considered to be significant under the landscaping section of the zoning ordinance if it is at least five caliper inches for deciduous trees and six caliper inches for conifers. Aspen, Cottonwood, or Silver Maple are considered significant if they are at least 12 inches in diameter at 4.5 feet from the ground. (Ord. No. 2325-07, 5-7-07; Ord. No. 2449-13, 11-15-2013)

*Site plan* means a plan, prepared to scale, showing accurately and with complete dimensioning, the boundaries of a site and the location of all buildings, structures, uses, and principal site development features proposed for a specific parcel of land.

*Solar energy system - building-integrated.* A solar energy system that is an integral part of a principal or accessory building, rather than a separate mechanical device, replacing or substituting for an architectural or structural component of the building. Building-integrated systems include but are not limited to active photovoltaic or hot water systems that are contained within roofing materials, windows, walls, skylights, and awnings, or passive systems that are designed to capture direct solar heat.

*Solar energy system - building-mounted.* A solar energy system affixed to a principal or accessory building.

*Solar energy system - freestanding.* A solar energy system with a supporting framework that is placed on or anchored in the ground and that is independent of any building or other structure. Garages, carports, or similar structures that incorporate building-integrated or building-mounted solar energy systems shall not be classified as freestanding solar energy systems and shall instead be subject to regulations governing accessory structures.

*Solar collector surface.* Any part of a solar energy system that absorbs solar energy for use in the system's transformation process. The collector surface does not include frames, supports, and mounting hardware.

*Solar energy.* Radiant energy received from the sun that can be collected in the form of heat or light by a solar collector.

*Solar energy system.* A device or structural design feature intended to provide for collection, storage, and distribution of solar energy for heating or cooling, electricity generating, or water heating.

*Stand* and *standing* mean any halting, even momentarily, of a vehicle, whether occupied or not, otherwise than temporarily for the purpose of and while actually engaged in receiving or discharging passengers or property.

*Stock car* means a motor vehicle of standard design and construction which is modified, adapted, or altered in any manner to increase its speed or safety, and designed or intended for operation on a speedway, racetrack, or other facility used or designed for high-speed contests between two or more vehicles or for timing of speed.

*Story* means that portion of a building included between the surface of any floor and the surface of the floor next above; or if there is not a floor above, the space between the floor and the ceiling next above. A basement shall not be counted as a story.

*Street* means a public or private thoroughfare with a minimum right-of-way width of 24 feet which is used, or intended to be used, for passage or travel by motor vehicles. Streets are further classified in the comprehensive plan by the functions they perform. See illustration following this definition.

- (1) *Local street*. Roadways typically having lowest traffic volumes, containing one lane of traffic in each direction whose primary function is to provide access to and from property.
- (2) *Minor collector*. Roadways containing one lane of traffic in each direction whose primary function is to provide access to and from neighborhoods and the local street system.
- (3) *Major collector*. Roadways containing one or two lanes of traffic in each direction with controlled intersections whose function is to serve long trips within the city and access to and from minor and principal arterials.
- (4) *Minor arterials*. Interregional roads containing two lanes in each direction with limited access and controlled intersections at other arterials and collector streets. Minor arterials convey traffic between towns, boroughs, or other urban centers and are used to reduce the number of trips on the regional system. Efficient movement is the primary function of a minor arterial road.
- (5) *Principal arterials*. Limited access interregional arterial routes containing two or more lanes in each direction. They are designed exclusively for unrestricted movement, have no private access, and intersect only with selected arterial highways or major streets by means of interchanges engineered for free-flowing movement.

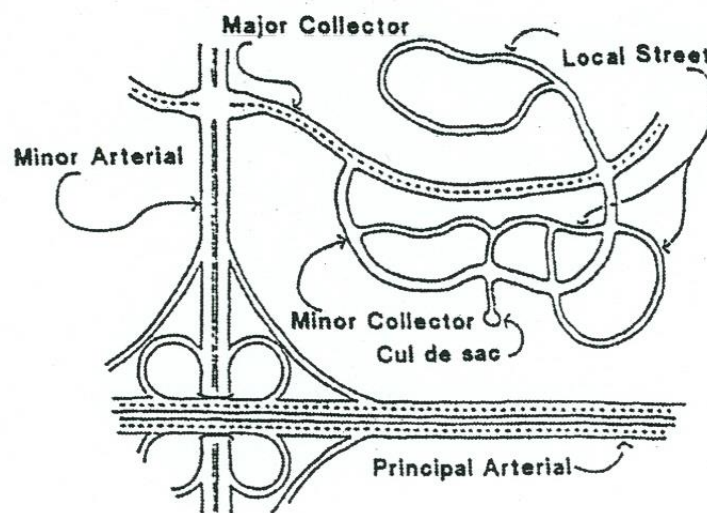

*Structure* means anything constructed or erected, the use of which requires a location on the ground, or attached to something having a location on the ground, including but without limiting the generality of the foregoing, advertising signs, billboards and fences.

*Trailer* means any vehicle designed for carrying property on its own structure and for being drawn by a motor vehicle.

*Trailer bed* means that portion of a trailer that is designed to make contact with and bear the weight of the load to be carried.

*Tree* means a self-supporting woody perennial plant having one or several self-supporting stems or trunks and numerous branches which normally attains an overall height of at least 15 feet at maturity. Trees may be classified as deciduous or evergreen.

*Truck* means every motor vehicle designed, used, or maintained primarily for the transportation of property. This definition does not include a pickup truck as defined in this section or a van with a manufacturer's nominal rated carrying capacity of one ton or less.

*Understory trees* means a self-supporting woody plant or species normally growing to a mature height of between 15 and 30 feet and a mature spread of at least 15 feet. Many understory trees are considered to be ornamental trees.

*Undue hardship* means a condition resulting when reasonable use cannot be made of a property if used under conditions allowed by the official control, the plight of the landowner is due to circumstances unique to his property not created by the landowner, and the variance, if granted, will not alter the essential character of the locality. Economic considerations alone shall not constitute an undue hardship if reasonable use for the property exists under the terms of this chapter.

*Use* means the purpose or activity for which a premises is designed, arranged or intended for which it is or may be occupied or maintained.

*Use district* means a mapped area within the city to which a uniform set of regulations applies for the purpose of regulating development.

*Uses, nonconforming*, means any building or land lawfully occupied by a use at the time of the passage of the ordinance from which this chapter is derived or of amendments thereof which does not conform after the passage of the ordinance from which this chapter is derived or an amendment thereto with the use regulations of the district in which it is located. See the definition, "Nonconforming."

*Variance* means a modification or variation of the provisions of this zoning code as applied to a specific piece of property. (Ord. No. 2409-12, 1-27-12)

*Vegetation, native*, means any plant species with a geographic distribution indigenous to all or part of the state. Plant species which have been introduced by man are not native vegetation.

*Vehicle* means a device for carrying or conveying persons or property which may be self-propelled or may be propelled, drawn, or towed by a self-propelled vehicle.

*Wetland* means an area that is inundated or saturated by surface water or groundwater at a frequency and duration sufficient to support, and that, under normal circumstances, does support a prevalence of vegetation typically adapted for life in saturated soil conditions, commonly known as hydrophytic vegetation.

*Wind energy conversion system (WECS)* means all necessary devices that together convert wind energy into electricity, including the rotor, nacelle, generator, tower, electrical components, foundation, transformer, and electrical cabling from the tower to building or substation(s) and their support facilities. (Ord. No. 2383-10, 5-28-10)

*Wind energy conversion system, building mounted* means a wind energy conversion system that is attached to a building for structural support. (Ord. No. 2383-10, 5-28-10)

*Wind energy conversion system tower* means a support structure to which the nacelle and rotor are attached. (Ord. No. 2383-10, 5-28-10)

*Wind energy conversion system height* means the distance measured from the lowest exterior grade at the base of the WECS to the highest point of any component of a WECS. (Ord. No. 2383-10, 5-28-10)

*Yard* means a required open space on a lot, which is unoccupied and unobstructed by a structure from its lowest ground level to the sky except as expressly permitted in this chapter. The yard shall extend along a lot line and at right angles to the lot line to a depth or width specified in the yard regulations for the district in which the lot is located.

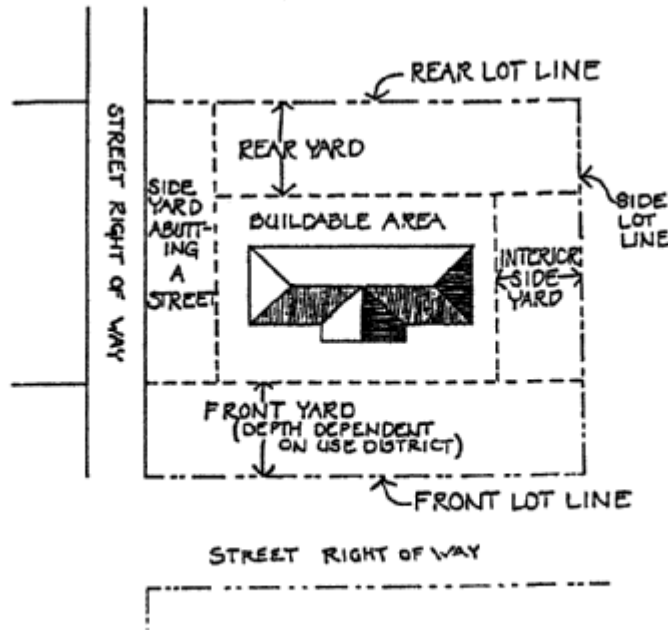

Yard

*Yard, front,* means an area which extends along the full width of the front lot line between side lot lines and toward the rear lot line a depth as specified in the required yard regulations for the district in which such lot is located.

*Yard, rear,* means an area which extends along the full width of the rear lot line between the side lot lines and toward the front lot line a depth as specified in the required yard regulations for the district in which the lot is located. Where the lot is a corner lot, the rear yard shall be the area between the interior side lot line and the side yard abutting a street extending toward the front yard a depth as specified in the required yard regulations for the district in which the lot is located.

*Yard, side,* means an area extending along a side lot line between the front yard and rear yard, having a width as specified in the required yard regulations for the district in which the lot is located.

*Yard, side, abutting a street,* means a yard adjacent to a street which extends along a side lot line between the front yard and rear property line. The required width of the side yard abutting a street is specified in the dimensional standards of the district in which the yard is located.

*Yard waste* means all garden wastes, grass clippings, leaves, weeds, holiday trees, shrub and tree waste and prunings, seasonal greenery, and woodchips that are normally generated from residential properties. (Ord. No. 2452-14, 5-2-2014)

*Zoning ordinance* means Ordinance No. 92-1902 and all amendments adopted subsequent to that date and compiled as Chapter 36 of this Code.

(Code 1976, § 14:3-1; Ord. No. 2192-01, 3-5-2001; Ord. No. 2197-01, 5-21-2001; Ord. No. 2232-02, § 2, 11-4-2002; Ord. No. 2255-03, 11-3-2003; Ord. No. 2325-07, 5-7-2007; Ord. No. 2367-09, 1-23-2009; Ord. No. 2383-10, 5-28-2010; Ord. No. 2409-12, 1-27-2012; Ord. No. 2418-12, 9-14-2012; Ord. No. 2426-12, 12-14-2012; Ord. No. 2452-14, 5-2-2014; Ord. No. 2575-19, 11-18-19; Ord. No. 2596-20, 10-19-20; Ord. No. 2598-20, 11-16-20; Ord. No. 2640-22, 1-18-22)

**Cross reference(s)**--Definitions generally, § 1-2.

**Sec. 36-5. Abbreviations.**

**(a) Purpose.** The purpose of this section is to identify the abbreviations which are used in this chapter in order to clarify meaning.

**(b) Abbreviations.**

(1)	BOZA	Board of zoning appeals
(2)	DBH	Diameter at breast height
(3)	DU	Dwelling unit
(4)	FAR	Floor area ratio
(5)	PUD	Planned unit development
(6)	FW	Floodway district
(7)	FF	Flood fringe district
(8)	FP	General floodplain district

(Code 1976, § 14:3-2)

**Secs. 36-6--36-29. Reserved.**

(Ord. No. 2462-15, 2-2-2015)